

BLADE

CRIBA220

SCHEDA RICAMBI | SPARE PARTS SHEET

rev.01_05/2024

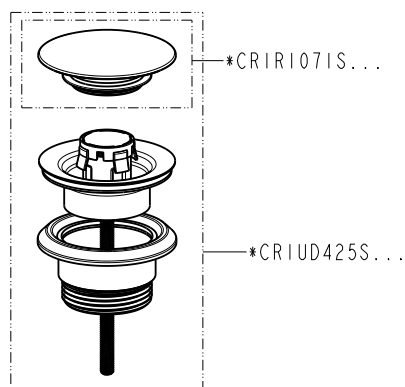
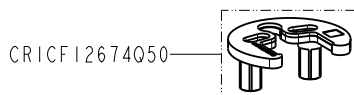
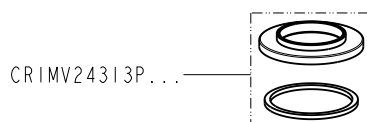
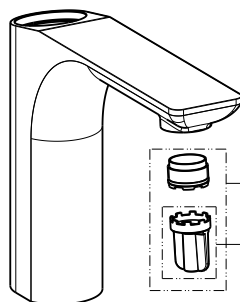
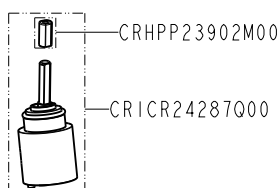
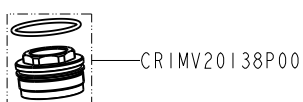
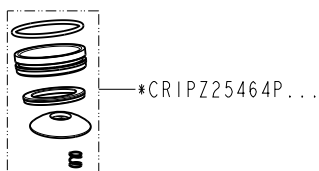
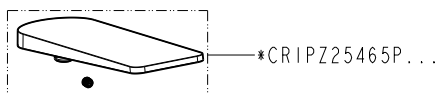

NOTE | NOTES

* completare con codice finitura | complete with finishing code